

# ***Wireless Stereo Headphone System***

---

Operating Instructions

***MDR-RF845RK  
MDR-RF815RK***

## WARNING

**To prevent fire or shock hazard, do not expose the unit to rain or moisture.**

**To avoid electrical shock, do not open the cabinet. Refer servicing to qualified personnel only.**



This equipment complies with the essential requirements of the Directive 1999/5/EC Radio and Telecommunications Terminal Equipment Directive.

This product is intended to be used in the following countries.

CEK version: United Kingdom

CED version: Germany, Sweden, Denmark,  
Finland, Norway, Belgium,  
Switzerland, Austria, Netherlands,  
France, Portugal, Italy

To check for version, please refer to the barcode label located on the top of the box.

## Welcome!

Thank you for purchasing the Sony MDR-RF845RK/RF815RK Wireless Stereo Headphone System. Before operating the unit, please read this manual thoroughly and retain it for future reference.

Some features are:

- Wireless system that allows you to listen to a program free from the restriction of a cord
- High fidelity sound reproduction
- A compact transmitter with an AC power adaptor (supplied) enables simple charging of the headphone battery. Just by placing the headphones on the transmitter, headphone battery can be charged.
- Comfortable Supra-aural headphones with self adjusting head band
- Automatic ON/OFF function on headphones to preserve battery power

---

# Notes on receiving performance

The system for this equipment utilizes very high frequency signals in the 800 MHz band so the receiving performance may deteriorate due to the surroundings. The following examples illustrate conditions that may reduce the possible receiving range or cause interference with reception.

- Inside a building with walls containing steel beams.
- Area with many steel file cabinets, etc.
- Area with many electrical appliances capable of generating electromagnetic noise.
- Transmitter is placed on a metal instrument.
- Area facing a roadway.
- Noise or interfering signals exist in the surroundings due to radio transceivers in trucks, etc.
- Noise or interfering signals exist in the surroundings owing to wireless communication systems installed along roadways.

---

# Table of contents

---

## Getting started

Unpacking .....	4
Setting up the transmitter .....	4
Charging the headphone battery .....	6

---

## Operating the system

Listening to a program .....	7
The effective areas of the transmitter .....	9
Replacing the ear pads .....	9

---

## Additional information

Precautions .....	10
Troubleshooting .....	10
Specifications .....	11

## Unpacking

Check that you have the following items:

- The headphones



- The transmitter

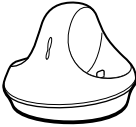

- AC power adaptor

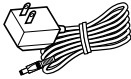

- Unimatch plug adaptor (stereo mini jack ↔ stereo phone plug)



- Connecting cord (phono plugs ↔ stereo mini plug), 1 m



## Setting up the transmitter

- 1 Connect the transmitter to audio/video equipment. Select one of the hookups below depending on the jack type:

- Ⓐ To connect to a headphones jack

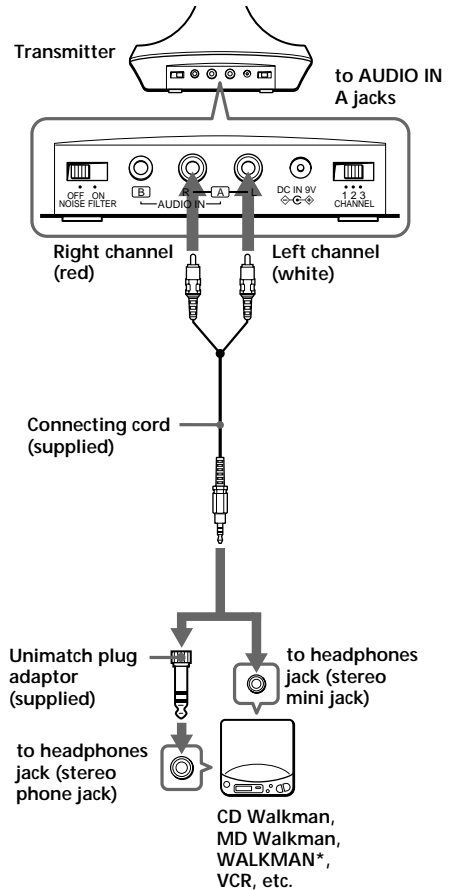

- Ⓑ To connect to LINE OUT or REC OUT jacks

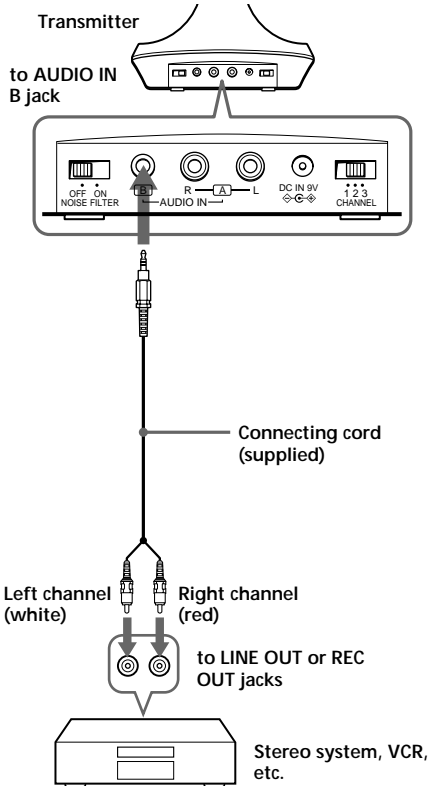

- Ⓒ To connect to TV, etc.

If noise occurs when the transmitter is connected to your TV or VCR, set the NOISE FILTER switch to ON.

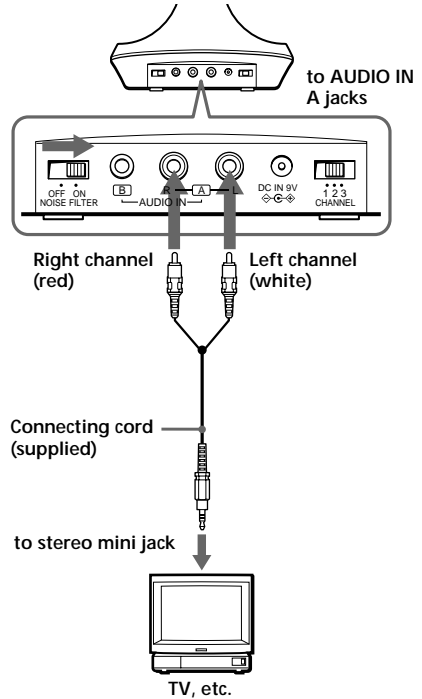

#### Notes

- If you connect the transmitter to LINE OUT or REC OUT jack of an audio reproducer such as an MD player or CD player, do not set the NOISE FILTER switch to ON. Otherwise, the volume will be limited.
- The NOISE FILTER switch is active only in the case of the connection shown in diagram Ⓐ on page 4 and Ⓒ. In diagram Ⓑ, the switch has no effect.
- When the transmitter is placed on or near a TV, it may pick up a noise. In such case, place the transmitter away from the TV.

*continue to next page*

Continued

**2** Connect the transmitter to an AC outlet using the supplied AC power adaptor.

**Notes**

- Use only the supplied AC power adaptor. Do not use any other AC power adaptor.



**Polarity of the plug**

- When you connect the transmitter directly to a monaural earphone jack, the audio signal will not be output through the right channel. In such a case, use the separately sold PC-236HG plug adaptor.
- If the connected equipment has the AVLS (Automatic Volume Limiter System) function, be sure to turn the function off when using the transmitter. Otherwise, you will have to turn up the volume of the headphones, and that may cause noise.

\* WALKMAN is a registered trademark of Sony Corporation.

## Charging the headphone battery

### Using the headphones for the first time

When you use the headphones for the first time, charge the battery in the following manner.

**1** Connect the transmitter to a power source.

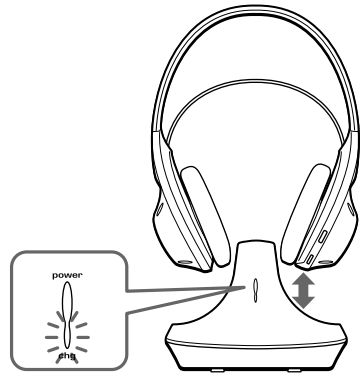
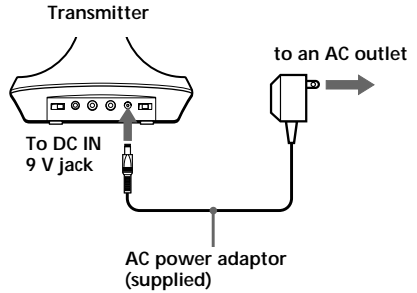

Place the headphone on the transmitter such that the charging pins on the transmitter engage the charging contacts on the bottom of the right-hand housing.

The charge indicator on the transmitter will light in green to indicate that the battery is being charged.

## Listening to a program

- 1 First turn on the audio/video equipment and start playing.
- 2 Remove the headphones from the transmitter. The transmitter's power indicator will light in red.

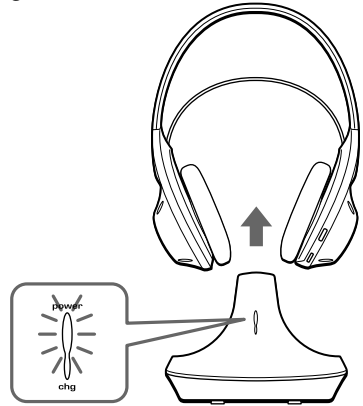

- 3 Select the radio frequency with the CHANNEL selector switch.

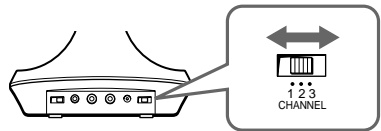

- 4 When you put on the headphones the headphone power turns on automatically.



### To recharge the headphone battery after use

Since little electric current is used for charging, there is no need to worry about overcharging.

### Charging and using hours

Approx. charging hours	Approx. using time*	
	MDR-RF845RK	MDR-RF815RK
1	50 minutes	55 minutes
24**	20 hours	23 hours

\* at 1 kHz, 1 mW + 1 mW output

\*\* The hours required to fully charge empty batteries

Continued

- 5-Ⓐ** Turn up the volume to a moderate level with the VOL control. Press the TUNING button briefly for automatic tuning of the headphones. If you do not receive a clear audio signal, press it again.

**Ⓐ MDR-RF845RK**

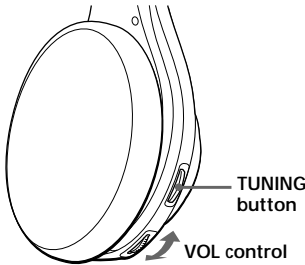

- 5-Ⓑ** Turn up the volume to a moderate level with the VOL control, then tune the headphones in to the frequency of the transmitter with the TUNING control until you can hear the audio signal loud and clear.

**Ⓑ MDR-RF815RK**

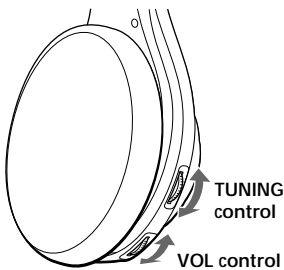

Try the above steps 3 and 5 until the receiving performance becomes better.

### **Sending RF signals from the Transmitter**

The transmitter starts sending the RF signals automatically, when it detects audio signals from the equipment connected.

If it does not detect an audio signal for more than approximately four minutes, the transmitter will stop sending RF signals, and the power indicator turns off.

When the transmitter receives an audio signal again, it starts sending the RF signals, and the power indicator will light in red again.

If the audio signal is very weak, the transmitter does not send RF signals. If the transmitter is connected to a headphone jack, make sure the volume of the equipment connected is set to 5 – 6 or higher.

You may not hear the beginning of the sound from the headphones until the transmitter starts sending the RF signals after detecting an audio signal.

### **Auto power on/off function**

When you remove the headphones from your head, the power turns off automatically. Do not allow the self adjusting band to be pulled up, otherwise the headphones will be switched on.

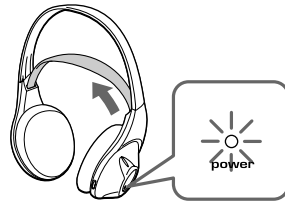

The power turns on.

### **Note**

If a hissing noise is heard move closer to the transmitter.



## The effective areas of the transmitter

The optimum distance is up to approximately 100 m without the system picking up some interference. However, the distance may vary according to the surroundings and environment. If the system picks up some noise while using it within the above mentioned distance, reduce the distance between the transmitter unit and the headphones, or select the other channel.

### Notes

- When you use the headphones inside the effective areas of the transmitter, the transmitter can be placed in any direction from the listener.
- Even within the signal reception area, there are some spots (dead spot) where the RF signal can not be received. This characteristics is inherent to RF signals, and does not indicate malfunction. By slightly moving the transmitter, location of the dead spot can be changed.

## Replacing the ear pads

When the ear pads become dirty or damaged, you can get replacements from your Sony dealer. Replace them as illustrated below.

- 1** Remove the old ear pad by pulling it out of the groove on the housing.

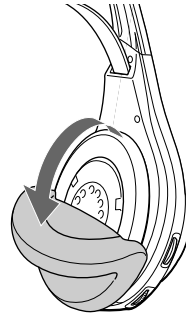

- 2** Place the new ear pad on the driver unit and insert the edge of the pad into the groove as illustrated.

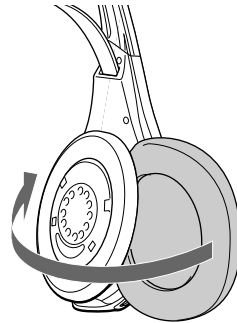

Make sure that the entire edge of the ear pad is securely inserted into the groove.

## Troubleshooting

### Precautions

- When the transmitter is not to be used for a long period of time, disconnect the AC power adaptor from the AC outlet holding the plug. Do not pull on the cord.
- Do not leave the wireless stereo headphone system in a location subject to direct sunlight, heat or moisture.

#### Notes on headphones

##### Preventing hearing damage

Avoid using headphones at high volume. Hearing experts advise against continuous, loud and extended play. If you experience a ringing in your ears, reduce the volume or discontinue use.

##### Caring for others

Keep the volume at a moderate level. This will allow you to hear outside sounds and to be considerate to the people around you.

If you have any questions or problems concerning the system that are not covered in this manual, please consult the nearest Sony dealer.

Be sure to bring the headphones and the transmitter to the Sony dealer when requiring repair work.

#### Disposing of the headphones

Be sure to remove the built-in rechargeable batteries from the headphones before you dispose of the headphones. First remove the left headphone's ear pad. You will see six screws. Remove the six screws and open the housing.

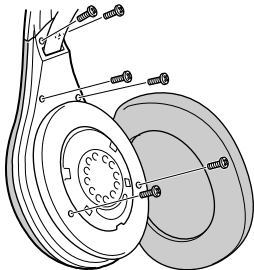

Problem	Solution
No sound/ Muffled sound	Check the connection of the audio/ video equipment or the AC power adaptor. <hr/> Check that the audio/video equipment is turned on. <hr/> Turn up the volume on the connected audio/video equipment, if the transmitter is connected to the headphones jack. <hr/> MDR-RF815RK: Change the radio frequency with the CHANNEL selector on the transmitter, then tune the headphones with the TUNING control. MDR-RF845RK: Change the radio frequency with the CHANNEL selector on the transmitter, then press the TUNING button again. <hr/> The mute function is activated. Use the headphones near the transmitter. <hr/> The headphones' POWER indicator light is weak or turned off. • Charge the built-in rechargeable battery or if the POWER indicator is still off after charging the built- in rechargeable battery, take the headphones to a Sony dealer for replacement of the rechargeable battery. <hr/> If you connect the transmitter to the LINE OUT or REC OUT jack of an audio reproducer, make sure that the NOISE FILTER switch is set to OFF. <hr/> Make sure that the NOISE FILTER switch is set to either ON or OFF (If the switch gets stuck between ON and OFF, the sound will be cut off).

<b>Problem</b>	<b>Solution</b>
Distortion	<p>If the transmitter is connected to the headphones jack, turn down the volume of the connected audio/video equipment.</p> <hr/> <p>Change the radio frequency with the CHANNEL selector on the transmitter.</p> <hr/> <p>The headphones' POWER indicator light is weak or turned off.</p> <ul style="list-style-type: none"> <li>• Charge the built-in rechargeable battery or if the POWER indicator is still off after charging the built-in rechargeable battery, take the headphones to a Sony dealer for replacement of the rechargeable battery.</li> </ul> <hr/> <p>If you connect the transmitter to LINE OUT or REC OUT jack of an audio reproducer, make sure that the NOISE FILTER switch is set to OFF.</p>
Loud background noise	<p>Move closer to the transmitter. As you move away from the transmitter, more noise is likely to be heard.</p> <hr/> <p>If the transmitter is connected to the headphones jack, turn up the volume of the connected audio/video equipment.</p> <hr/> <p>MDR-RF815RK: Change the radio frequency with the CHANNEL selector on the transmitter, then tune the headphones with the TUNING control.</p> <p>MDR-RF845RK: Change the radio frequency with the CHANNEL selector on the transmitter, then press the TUNING button again.</p> <hr/> <p>The headphones' POWER indicator light is weak or turned off.</p> <ul style="list-style-type: none"> <li>• Charge the built-in rechargeable battery or if the POWER indicator is still off after charging the built-in rechargeable battery, take the headphones to a Sony dealer for replacement of the rechargeable battery.</li> </ul> <hr/> <p>If you connect the transmitter to the LINE OUT or REC OUT jack of an audio reproducer, make sure that the NOISE FILTER switch is set to OFF.</p>

## Specifications

### General

Carrier frequency	863.5 – 864.5 MHz
Channel	Ch1, Ch2, Ch3
Modulation	FM stereo
Frequency response	20 – 20,000 Hz

### Transmitter TMR-RF845R, TMR-RF815R

Power source	DC 9 V: supplied AC power adaptor
Audio input	phono jacks/stereo mini jack
Dimensions	Approx. 150 mm dia × 108 mm (6 × 4 1/3 in.) (w/h)
Mass	Approx. 190 g (6.7 oz.)

### Headphones MDR-RF845R, MDR-RF815R

Power source	DC 2.4 V: Built-in rechargeable battery
Mass	Approx. 240 g (8.5 oz.) incl. built-in rechargeable battery

### Built-in Ni-Cd rechargeable battery

Model name	NC-AA
Voltage	1.2 V
Capacity	700 mAh

### Optional accessory

Plug adaptor	PC-236HG (stereo mini jack ↔ monaural mini plug)
--------------	--

Design and specifications are subject to change without notice.



### Svenska

Den här utrustningen uppfyller de väsentligaste kraven enligt 1999/5/EC Radio and Telecommunications Terminal Equipment Directive.

Den här produkten är avsedd att användas i följande länder.

Version CEK: Storbritannien

Version CED: Tyskland, Sverige, Danmark, Finland, Norge, Belgien, Schweiz, Österrike, Nederländerna, Frankrike, Portugal, Italien

Produktens version framgår av streckkodsetiketten på lådans översida.

### Dansk

Dette udstyr er fundet i overensstemmelse med de grundlæggende krav i direktivet 1999/5/EC (direktiv vedrørende terminaludstyr i radio og telekommunikation).

Dette produkt er beregnet til brug i følgende lande.

CEK-version: Storbritannien

CED-version: Tyskland, Sverige, Danmark, Finland, Norge, Belgien, Schweiz, Østirig, Holland, Frankrig, Portugal og Italien.

Øverst på kassen findes en stregkode, hvor du kan se, hvilken version kassen indeholder.

### Suomi

Tämä laite on radio- ja telepäätelaitteista ja niiden vaatimustenmukaisuuden vastavuoroisesta tunnustamisesta koskevan direktiivin mukainen (1999/5/EY).

Tämä tuote on tarkoitettu käytettäväksi seuraavassa maissa.

CEK-malli: Iso-Britannia

CED-malli: Saksa, Ruotsi, Tanska, Suomi, Norja, Belgia, Sveitsi, Itävalta, Alankomaat, Ranska, Portugal, Italia

Näet version pakkauksen yläosassa olevasta viivakooditarrasta.

### Norsk

Dette utstyret er kompatibelt med de viktigste kravene i direktivet 1999/5/EC Radio and Telecommunications Terminal Equipment.

Dette produktet er ment for bruk i følgende land:

CEK-versjon: Storbritannia

CED-versjon: Tyskland, Sverige, Danmark, Finland, Norge, Belgia, Sveits, Østerrike, Nederland, Frankrike, Portugal, Italia

Du kan sjekke versjon ved å se på strekkode-etiketten på toppen av esken.

### Ελληνικά

Αυτός ο εξοπλισμός συμμορφώνεται με τις βασικές απαιτήσεις της Οδηγίας 1999/5/ΕΕ "Εξοπλισμός Ραδιοφώνου και Τηλεπικοινωνιακού Τερματικού".

Αυτό το προϊόν προορίζεται για να χρησιμοποιηθεί στις παρακάτω χώρες.

Έκδοση CEK: Ηνωμένο Βασίλειο

Έκδοση CED: Γερμανία, Σουηδία, Δανία, Φιλανδία, Νορβηγία, Βέλγιο, Ελβετία, Αυστρία, Ολλανδία, Γαλλία, Πορτογαλία, Ιταλία

Για να ελέγξετε την έκδοση, παρακαλούμε ανατρέξτε στην ετικέτα με τον κωδικό ραβδώσεων που βρίσκεται στο επάνω μέρος του κουτιού.

### Français

Cet équipement est conforme aux exigences de la directive 1999/5/EC relative aux radio et télécommunications (Radio and Telecommunications Terminal Equipment Directive).

Ce produit est conçu pour être utilisé dans les pays suivants.

Versions CEK : Royaume-Uni

Version CED : Allemagne, Suède, Danemark, Finlande, Norvège, Belgique, Suisse, Autriche, Pays-Bas, France, Portugal, Italie

Pour connaître la version que vous utilisez, veuillez vous reporter au code barre situé sur la partie supérieure de la boîte.

### Deutsch

Dieses Gerät entspricht den grundlegenden Anforderungen der Richtlinie 1999/5/EG für Radio- und Telekommunikationsendgeräte (R&TTE-Richtlinie).

Dieses Gerät kann in folgenden Ländern verwendet werden.

Version CEK: Großbritannien

Version CED: Deutschland, Schweden, Dänemark, Finnland, Norwegen, Belgien, Schweiz, Österreich, Niederlande, Frankreich, Portugal, Italien

Wenn Sie nachsehen wollen, um welche Version es sich bei Ihrem Modell handelt, schauen Sie bitte nach dem Strichcodeetikett oben auf dem Karton.

### Español

Este equipo cumple los requisitos esenciales de la Directiva 1999/5/CE sobre equipos terminales de telecomunicaciones y radio.

Este producto está destinado a utilizarse en los siguientes países:

Versión CEK: Reino Unido

Versión CED: Alemania, Suecia, Dinamarca, Finlandia, Noruega, Bélgica, Suiza, Austria, Holanda, Francia, Portugal, Italia

Para comprobar la versión, consulte la etiqueta del código de barras situada en la parte superior de la caja.

### Nederlands

Dit product beantwoordt aan de essentiële vereisten bepaald in Richtlijn 1999/5/EG (Richtlijn m.b.t. radio en telecommunicatie eindapparatuur).

Dit product is bestemd voor gebruik in de volgende landen:

CEK versie: Verenigd Koninkrijk

CED versie: Duitsland, Zweden, Denemarken, Finland, Noorwegen, België, Zwitserland, Oostenrijk, Nederland, Frankrijk, Portugal, Italië

De versie vindt u op het barcode label boven op de doos.

### Italiano

Questo prodotto è conforme ai requisiti fondamentali specificati nella direttiva 1999/5/EC (Direttiva R&TTE).

Il presente prodotto è destinato all'utilizzo nei paesi elencati di seguito.

Versione CEK: Regno Unito

Versione CED: Germania, Svezia, Danimarca, Finlandia, Norvegia, Belgio, Svizzera, Austria, Olanda, Francia, Portogallo, Italia

Per verificare la versione, fare riferimento all'etichetta con il codice a barre situata sulla parte superiore della scatola.

### Português

Este equipamento cumpre os requisitos essenciais da directiva 1999/5/EC referente a equipamento para terminais de telecomunicações e rádio (Radio and Telecommunications Terminal Equipment Directive).

Este produto destina-se a ser utilizado nos seguintes países:

Versão CEK: Reino Unido

Versão CED: Alemanha, Suécia, Dinamarca, Finlândia, Noruega, Bélgica, Suíça, Áustria, Países Baixos, França, Portugal, Itália

Para verificar a versão, consulte a etiqueta do código de barras localizada na parte de cima da caixa.