

# SONY®

3-229-569-23(1)

## FM Stereo/AM PLL Synthesized Radio

Operating Instructions  
Mode d'emploi  
Manual de instrucciones

### ICF-C1200

Sony Corporation © 2001 Printed in Japan  
Printed on recycled paper  
Soy ink less than 1% VOC (volatile organic compound) used

http://www.world.sony.com/

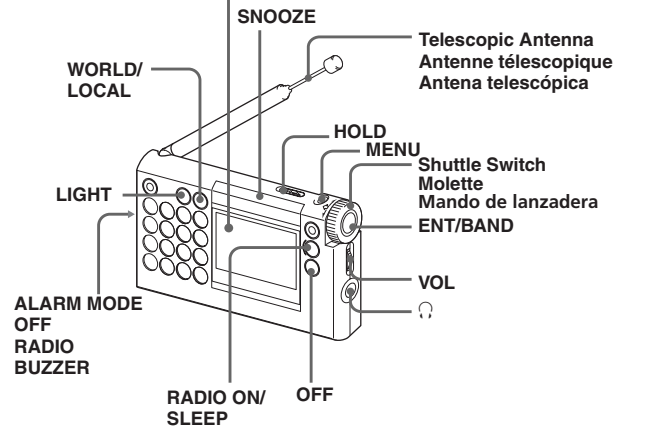
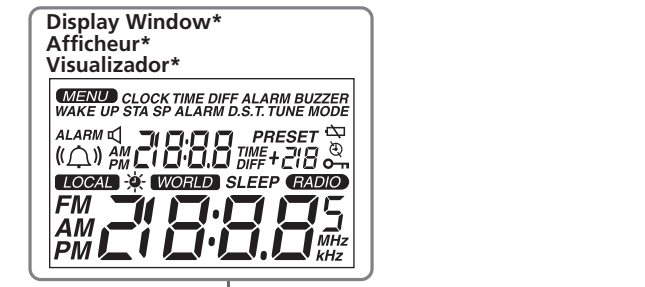

\* Part of the display window may differ in some countries.  
\* Il se peut qu'une partie de l'afficheur soit différente dans certains pays.  
\* Parte del visualizador puede diferir en algunos países.

**A**

R03 (size AAA) × 2  
Piles R03 (format AAA) × 2  
R03 (tamaño AAA) × 2

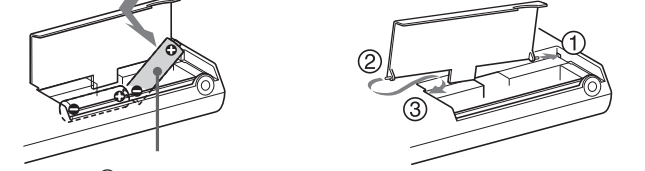

Insert the ⊖ side of the battery first.  
Insérez d'abord le pôle ⊖ de la pile.  
Inserte en primer lugar el lado ⊖ de las pilas.

**B**

Turn/keep turning  
Rotation/rotation  
maintenue  
Gire/mantenga  
girado

Press/hold  
down  
Presion/  
pression  
maintenue  
Presión/  
presión  
continua

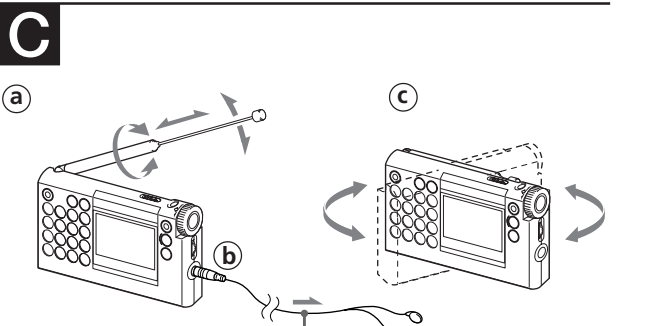

Stereo headphones  
Casque d'écoute compris  
Auriculares estero

**Using ENT(enter)/BAND**

How to use: Press. Hold down until you hear the confirmation beep when presetting the station. (see Fig. 1B-②)

Function: Decides any changes to the settings and changes the band.

**English**

**For customers in the U.S.A.**

You are cautioned that any changes or modifications not expressly approved in this manual could void your authority to operate this equipment.

**Owner's Record**

The model number and the serial number are located on the rear. Record the serial number in the space provided below. Refer to them whenever you call upon your Sony dealer regarding this product.

Model No. ICF-C1200

Serial No. \_\_\_\_\_

**Before You Begin**

Thank you for choosing the Sony radio! It will give you many hours of reliable service and listening pleasure. Before operating the radio, please read these instructions thoroughly and retain them for future reference.

**Features**

- Easy-to-use Large LCD with dual time display (current time / alarm time)
- 20 station presets for FM/AM
- Single alarm function - selectable from Radio or buzzer sounds.
- Selectable alarm output - from speaker or stereo headphones.
- Protected by carrying cover, which also works as a stand.
- World time adjusting function.
- Extendable snooze - from 10 min. up to 60 min.

**Notes on AM channel step**

The AM channel step differs depending on area. See "Changing AM Channel Step".

**Precautions**

- Operate the radio only on 3.0V DC with two R03 (size AAA) batteries.
- The nameplate indicating operating voltage, etc. is located on the rear exterior.
- Avoid exposure to temperature extremes, direct sunlight, moisture, sand, dust or mechanical shock. Never leave in a car parked in the sun.
- Should any solid object or liquid fall into the unit, remove the batteries, and have the unit checked by a qualified person before operating it any further.
- In vehicles or buildings, radio reception may be difficult or noisy. Try listening near a window.
- Since a strong magnet is used for the speakers, keep personal credit cards using magnetic coding or spring-wound watches away from the unit to prevent possible damage from the magnet.
- To clean the casing, use a soft cloth dampened with a mild detergent solution.

**Notes on Headphones**

Road safety

Do not use headphones while driving, cycling, or operating any motorized vehicle. It may create a traffic hazard and is illegal in many areas. It will also be potentially dangerous to play your headphones at high volume while walking, especially at pedestrian crossings. Use should be exercised with extreme caution or discontinued use in potentially hazardous situations.

**Preventing hearing damage**

Avoid using headphones at high volume. Hearing experts advise against continuous, loud and extended play. If you experience a ringing in your ears, reduce volume or discontinue use.

**Caring for others**

Keep the volume at a moderate level. This will allow you to hear outside sounds and to be considerate to people around you.

**Warning**

If there is lightning when you are using the unit, take off the headphones immediately. If you have any questions or problems concerning your unit, please consult your nearest Sony dealer.

**Installing the Batteries**  
(See Fig. 1A-②)

**1** Open the battery compartment lid and install two batteries.

When the batteries are first installed, "LOCAL AM12:00" or "LOCAL 0:00" flashes in the display. Once the current time is set, the flashing stops.

**2** Close the lid.

**Battery Life (Approx. hours) (JEITA\*)**

	FM	AM		
Sony alkaline	47	29	60	34
LR03 (size AAA)				
Sony R03	21	12	29	16

\* Measured value by the standard of JEITA (Japan Electronics and Information Technology Industries Association). The battery life may shorten depending on the operation of the unit.

**You can check the remaining battery power in the display.**

The indicators are as follows:

- Weakening
- Exhausted. You can set the clock and the alarm, but you cannot operate the radio. If you set the radio alarm, the buzzer alarm will come on instead. When the batteries become exhausted, the unit will give a long beep and then turn off. Replace with new batteries. Press RADIO ON/SLEEP to delete after installing the batteries.

**Operating the Radio**

**1** Press OFF to turn off the power.

**2** Hold down MENU for about 5 seconds. "MENU" will be displayed, until you hear the confirmation beep.

**3** Turn the shuttle switch up or down to select "9 kHz" or "10 kHz" and press ENT/BAND.

**4** Turn the shuttle switch up or down to delete "PRESET" and press ENT/BAND. "PRESET" does not appear in manual tuning.

**5** Press RADIO ON/SLEEP.

The frequency that you tuned in to last time is displayed.

If "FM" is in the display, slide HOLD to turn off the HOLD function.

**2** Press MENU.

**3** Turn the shuttle switch up or down to select "TUNE MODE" and press ENT/BAND.

**4** Turn the shuttle switch up or down to delete "PRESET" and press ENT/BAND. "PRESET" does not appear in manual tuning.

**5** Press ENT/BAND to select the band.

**6** Turn the shuttle switch up or down to select the desired frequency.

When the frequency is received you will hear the broadcast. After a while, the frequency display changes to the clock display.

One turn of the shuttle switch changes the frequency by 0.1 MHz or 0.05 MHz for FM and 9 kHz for 10 kHz as determined by your AM channel step settings for AM. If you keep turning the shuttle switch up or down, the frequency changes rapidly. When the frequency matches the broadcast frequency, the broadcast will be received.

**Operating the Radio**

**1** Press RADIO ON/SLEEP.

The frequency that you tuned in to last time is displayed.

If "FM" is in the display, slide HOLD to turn off the HOLD function.

**2** Press MENU.

**3** Turn the shuttle switch up or down to select "TUNE MODE" and press ENT/BAND.

**4** Turn the shuttle switch up or down to delete "PRESET" and press ENT/BAND. "PRESET" does not appear in manual tuning.

**5** Press ENT/BAND to select the band.

**6** Turn the shuttle switch up or down to select the desired frequency.

When the frequency is received you will hear the broadcast. After a while, the frequency display changes to the clock display.

One turn of the shuttle switch changes the frequency by 0.1 MHz or 0.05 MHz for FM and 9 kHz for 10 kHz as determined by your AM channel step settings for AM. If you keep turning the shuttle switch up or down, the frequency changes rapidly. When the frequency matches the broadcast frequency, the broadcast will be received.

**Using the Shuttle Switch**

How to use: Turn up or down/keep turning (see Fig. 1B-②)

When you release your finger, the shuttle switch will return to its original position.

Function: Selects "MENU", changes the settings and the frequencies and set the clock.

**World/Local**

Telescopic Antenna  
Antenne télescopique  
Antena telescópica

Shuttle Switch  
Molette  
Mando de lanzadera  
ENT/BAND

VOL

RADIO ON/SLEEP

OFF

**World/Local**

Telescopic Antenna  
Antenne télescopique  
Antena telescópica

Shuttle Switch  
Molette  
Mando de lanzadera  
ENT/BAND

VOL

RADIO ON/SLEEP

OFF

**World/Local**

Telescopic Antenna  
Antenne télescopique  
Antena telescópica

Shuttle Switch  
Molette  
Mando de lanzadera  
ENT/BAND

VOL

RADIO ON/SLEEP

OFF

**World/Local**

Telescopic Antenna  
Antenne télescopique  
Antena telescópica

Shuttle Switch  
Molette  
Mando de lanzadera  
ENT/BAND

VOL

RADIO ON/SLEEP

OFF

**World/Local**

Telescopic Antenna  
Antenne télescopique  
Antena telescópica

Shuttle Switch  
Molette  
Mando de lanzadera  
ENT/BAND

VOL

RADIO ON/SLEEP

OFF

**7** Adjust the volume with VOL.

Note

If you connect the headphones cord to the jack, the sound does not come from the speaker.

**French**

**To turn off the radio**

Press OFF.

**Improving Reception**

**FM (See Fig. 1B-②)**

Extend the telescopic antenna and adjust the angle and length for the best reception.

The stereo headphones cord serves as the antenna, so extend it as long as possible. In this case, the telescopic antenna does not function (see Fig. 1B-②).

**AM (See Fig. 1C-②)**

An AM antenna is built into the unit. Rotate the unit horizontally until you get the best reception. (Do not operate the unit over a steel deck or metal surface, as this may lead to interference of reception.)

**Notes**

- Adjust the direction of the antenna, holding the bottom of it. The antenna, which can be damaged when you move the antenna, holding the tip of it.
- Rotate the antenna slowly, otherwise, it might hit the unit.

**World/Local**

Telescopic Antenna  
Antenne télescopique  
Antena telescópica

Shuttle Switch  
Molette  
Mando de lanzadera  
ENT/BAND

VOL

RADIO ON/SLEEP

OFF

**World/Local**

Telescopic Antenna  
Antenne télescopique  
Antena telescópica

Shuttle Switch  
Molette  
Mando de lanzadera  
ENT/BAND

VOL

RADIO ON/SLEEP

OFF

**World/Local**

Telescopic Antenna  
Antenne télescopique  
Antena telescópica

Shuttle Switch  
Molette  
Mando de lanzadera  
ENT/BAND

VOL

RADIO ON/SLEEP

OFF

**World/Local**

Telescopic Antenna  
Antenne télescopique  
Antena telescópica

Shuttle Switch  
Molette  
Mando de lanzadera  
ENT/BAND

VOL

RADIO ON/SLEEP

OFF

**World/Local**

Telescopic Antenna  
Antenne télescopique  
Antena telescópica

Shuttle Switch  
Molette  
Mando de lanzadera  
ENT/BAND

VOL

RADIO ON/SLEEP

OFF

**World/Local**

Telescopic Antenna  
Antenne télescopique  
Antena telescópica

Shuttle Switch  
Molette  
Mando de lanzadera  
ENT/BAND

VOL

RADIO ON/SLEEP

OFF

**World/Local**

Telescopic Antenna  
Antenne télescopique  
Antena telescópica

Shuttle Switch  
Molette  
Mando de lanzadera  
ENT/BAND

VOL

RADIO ON/SLEEP

OFF

**World/Local**

Telescopic Antenna  
Antenne télescopique  
Antena telescópica

Shuttle Switch  
Molette  
Mando de lanzadera  
ENT/BAND

VOL

RADIO ON/SLEEP

OFF

**World/Local**

Telescopic Antenna  
Antenne télescopique  
Antena telescópica

Shuttle Switch  
Molette  
Mando de lanzadera  
ENT/BAND

VOL

RADIO ON/SLEEP

OFF

**World/Local**

Telescopic Antenna  
Antenne télescopique  
Antena telescópica

Shuttle Switch  
Molette  
Mando de lanzadera  
ENT/BAND

VOL

RADIO ON/SLEEP

OFF

**World/Local**

Telescopic Antenna  
Antenne télescopique  
Antena telescópica

Shuttle Switch  
Molette  
Mando de lanzadera  
ENT/BAND

VOL

RADIO ON/SLEEP

OFF

**World/Local**

Telescopic Antenna  
Antenne télescopique  
Antena telescópica

Shuttle Switch  
Molette  
Mando de lanzadera  
ENT/BAND

VOL

RADIO ON/SLEEP

OFF

**World/Local**

Telescopic Antenna  
Antenne télescopique  
Antena telescópica

Shuttle Switch  
Molette  
Mando de lanzadera  
ENT/BAND

VOL

RADIO ON/SLEEP

OFF

**Utilisation de ENT(validation)/BAND**

Utilisation: Appuyez. Maintenez enfoncé jusqu'à ce que vous entendiez le bip lors du pré réglage de la station. (Voir Fig. 1B-②)

Fonction: Elle permet les changements des réglages et de la gamme d'onde.

**World/Local**

Telescopic Antenna  
Antenne télescopique  
Antena telescópica

Shuttle Switch  
Molette  
Mando de lanzadera  
ENT/BAND

VOL

RADIO ON/SLEEP

OFF

**World/Local**

Telescopic Antenna  
Antenne télescopique  
Antena telescópica

Shuttle Switch  
Molette  
Mando de lanzadera  
ENT/BAND

VOL

RADIO ON/SLEEP

OFF

**World/Local**

Telescopic Antenna  
Antenne télescopique  
Antena telescópica

Shuttle Switch  
Molette  
Mando de lanzadera  
ENT/BAND

VOL

RADIO ON/SLEEP

OFF

**World/Local**

Telescopic Antenna  
Antenne télescopique  
Antena telescópica

Shuttle Switch  
Molette  
Mando de lanzadera  
ENT/BAND

VOL

RADIO ON/SLEEP

OFF

**World/Local**

Telescopic Antenna  
Antenne télescopique  
Antena telescópica

Shuttle Switch  
Molette  
Mando de lanzadera  
ENT/BAND

VOL

RADIO ON/SLEEP

OFF

**World/Local**

Telescopic Antenna  
Antenne télescopique  
Antena telescópica

Shuttle Switch  
Molette  
Mando de lanzadera  
ENT/BAND

VOL

RADIO ON/SLEEP

OFF

**World/Local**

Telescopic Antenna  
Antenne télescopique  
Antena telescópica

Shuttle Switch  
Molette  
Mando de lanzadera  
ENT/BAND

VOL

RADIO ON/SLEEP

OFF

**World/Local**

Telescopic Antenna  
Antenne télescopique  
Antena telescópica

Shuttle Switch  
Molette  
Mando de lanzadera  
ENT/BAND

VOL

RADIO ON/SLEEP

OFF

**World/Local**

Telescopic Antenna  
Antenne télescopique  
Antena telescópica

Shuttle Switch  
Molette  
Mando de lanzadera  
ENT/BAND

VOL

RADIO ON/SLEEP

OFF

**World/Local**

Telescopic Antenna  
Antenne télescopique  
Antena telescópica

Shuttle Switch  
Molette  
Mando de lanzadera  
ENT/BAND

VOL

RADIO ON/SLEEP

OFF

**World/Local**

Telescopic Antenna  
Antenne télescopique  
Antena telescópica

Shuttle Switch  
Molette  
Mando de lanzadera  
ENT/BAND

VOL

RADIO ON/SLEEP

OFF

**World/Local**

Telescopic Antenna  
Antenne télescopique  
Antena telescópica

Shuttle Switch  
Molette  
Mando de lanzadera  
ENT/BAND

VOL

RADIO ON/SLEEP

OFF

**World/Local**

Telescopic Antenna  
Antenne télescopique  
Antena telescópica

Shuttle Switch  
Molette  
Mando de lanzadera  
ENT/BAND

VOL

RADIO ON/SLEEP

OFF

**5** Appuyez sur ENT(validation)/BAND pour sélectionner la gamme.

**6** Tournez la molette dans un sens ou l'autre pour sélectionner la fréquence souhaitée.

Lorsque le réglage est reçu, vous entendez l'émission. Quelques instants plus tard, l'indication de la fréquence est remplacée par l'heure.

A chaque rotation de la molette, la fréquence change de 0.1 MHz ou 0.05 MHz pour la gamme FM et de 9 kHz (ou 10 kHz selon le réglage de l'intervalle d'accord AM) pour la gamme AM. Si vous maintenez la molette tournée dans un sens ou l'autre, la fréquence change plus rapidement. Lorsque le réglage correspond à la fréquence d'émission, celle-ci est reçue.

**World/Local**

Telescopic Antenna  
Antenne télescopique  
Antena telescópica

Shuttle Switch  
Molette  
Mando de lanzadera  
ENT/BAND

VOL

RADIO ON/SLEEP

OFF

**World/Local**

Telescopic Antenna  
Antenne télescopique  
Antena telescópica

Shuttle Switch  
Molette  
Mando de lanzadera  
ENT/BAND

VOL

RADIO ON/SLEEP

OFF

**World/Local**

Telescopic Antenna  
Antenne télescopique  
Antena telescópica

Shuttle Switch  
Molette  
Mando de lanzadera  
ENT/BAND

VOL

RADIO ON/SLEEP

OFF

**World/Local**

Telescopic Antenna  
Antenne télescopique  
Antena telescópica

Shuttle Switch  
Molette  
Mando de lanzadera  
ENT/BAND

VOL

RADIO ON/SLEEP

OFF

**World/Local**

Telescopic Antenna  
Antenne télescopique  
Antena telescópica

Shuttle Switch  
Molette  
Mando de lanzadera  
ENT/BAND

VOL

RADIO ON/SLEEP

OFF

**World/Local**

Telescopic Antenna  
Antenne télescopique  
Antena telescópica

Shuttle Switch  
Molette  
Mando de lanzadera  
ENT/BAND

VOL

RADIO ON/SLEEP

OFF

**World/Local**

Telescopic Antenna  
Antenne télescopique  
Antena telescópica

Shuttle Switch  
Molette  
Mando de lanzadera  
ENT/BAND

VOL

RADIO ON/SLEEP

OFF

**World/Local**

Telescopic Antenna  
Antenne télescopique  
Antena telescópica

Shuttle Switch  
Molette  
Mando de lanzadera  
ENT/BAND

VOL

RADIO ON/SLEEP

OFF

**World/Local**

Telescopic Antenna  
Antenne télescopique  
Antena telescópica

Shuttle Switch  
Molette  
Mando de lanzadera  
ENT/BAND

VOL

RADIO ON/SLEEP

OFF

**World/Local**

Telescopic Antenna  
Antenne télescopique  
Antena telescópica

Shuttle Switch  
Molette  
Mando de lanzadera  
ENT/BAND

VOL

RADIO ON/SLEEP

OFF

**World/Local**

Telescopic Antenna  
Antenne télescopique  
Antena telescópica

Shuttle Switch  
Molette  
Mando de lanzadera  
ENT/BAND

VOL

RADIO ON/SLEEP

OFF

**World/Local**

Telescopic Antenna  
Antenne télescopique  
Antena telescópica

Shuttle Switch  
Molette  
Mando de lanzadera  
ENT/BAND

VOL

RADIO ON/SLEEP

OFF

**World/Local**

Telescopic Antenna  
Antenne télescopique  
Antena telescópica

Shuttle Switch  
Molette  
Mando de lanzadera  
ENT/BAND

VOL

RADIO ON/SLEEP

OFF

**3** Gire le mando de lanzadera hacia arriba o hacia abajo para seleccionar "TUNE MODE" y presione el botón ENT/BAND.

**4** Gire el mando de lanzadera hacia arriba o hacia abajo para borrar "PRESET" y presione el botón ENT/BAND. "PRESET" no aparecerá en la sintona manual.

**World/Local**

Telescopic Antenna  
Antenne télescopique  
Antena telescópica

Shuttle Switch  
Molette  
Mando de lanzadera  
ENT/BAND

VOL

RADIO ON/SLEEP

OFF

**World/Local**

Telescopic Antenna  
Antenne télescopique  
Antena telescópica

Shuttle Switch  
Molette  
Mando de lanzadera  
ENT/BAND

VOL

RADIO ON/SLEEP

OFF

**World/Local**

Telescopic Antenna  
Antenne télescopique  
Antena telescópica

Shuttle Switch  
Molette  
Mando de lanzadera  
ENT/BAND

VOL

RADIO ON/SLEEP

OFF

**World/Local**

Telescopic Antenna  
Antenne télescopique  
Antena telescópica

Shuttle Switch  
Molette  
Mando de lanzadera  
ENT/BAND

VOL

RADIO ON/SLEEP

OFF

**World/Local**

Telescopic Antenna  
Antenne télescopique  
Antena telescópica

Shuttle Switch  
Molette  
Mando de lanzadera  
ENT/BAND

VOL

RADIO ON/SLEEP

OFF

**World/Local**

Telescopic Antenna  
Antenne télescopique  
Antena telescópica

Shuttle Switch  
Molette  
Mando de lanzadera  
ENT/BAND

VOL

RADIO ON/SLEEP

OFF

**World/Local**

Telescopic Antenna  
Antenne télescopique  
Antena telescópica

Shuttle Switch  
Molette  
Mando de lanzadera  
ENT/BAND

VOL

RADIO ON/SLEEP

OFF

**World/Local**

Telescopic Antenna  
Antenne télescopique  
Antena telescópica

Shuttle Switch  
Molette  
Mando de lanzadera  
ENT/BAND

VOL

RADIO ON/SLEEP

OFF

**World/Local**

Telescopic Antenna  
Antenne télescopique  
Antena telescópica

Shuttle Switch  
Molette  
Mando de lanzadera  
ENT/BAND

VOL

RADIO ON/SLEEP

OFF

**World/Local**

Telescopic Antenna  
Antenne télescopique  
Antena telescópica

Shuttle Switch  
Molette  
Mando de lanzadera  
ENT/BAND

VOL

RADIO ON/SLEEP

OFF

**World/Local**

Telescopic Antenna  
Antenne télescopique  
Antena telescópica

Shuttle Switch  
Molette  
Mando de lanzadera  
ENT/BAND

VOL

RADIO ON/SLEEP

OFF

**World/Local**

Telescopic Antenna  
Antenne télescopique  
Antena telescópica

Shuttle Switch  
Molette  
Mando de lanzadera  
ENT/BAND

VOL

RADIO ON/SLEEP

OFF

**Utilización del mando de lanzadera**

Forma de utilización: Gírela hacia arriba o hacia abajo/manténgalo girado (Consulte la fig. 1B-②)

Cuando separe el dedo, el mando de lanzadera volverá a su posición original.

Función: Selecciona "MENU" y permite cambiar sus opciones.

**World/Local**

Telescopic Antenna  
Antenne télescopique  
Antena telescópica

Shuttle Switch  
Molette  
Mando de lanzadera  
ENT/BAND

VOL

RADIO ON/SLEEP

OFF

**World/Local**

Telescopic Antenna  
Antenne télescopique  
Antena telescópica

Shuttle Switch  
Molette  
Mando de lanzadera  
ENT/BAND

VOL

RADIO ON/SLEEP

OFF

**World/Local**

Telescopic Antenna  
Antenne télescopique  
Antena telescópica

Shuttle Switch  
Molette  
Mando de lanzadera  
ENT/BAND

VOL

RADIO ON/SLEEP

OFF

**World/Local**

Telescopic Antenna  
Antenne télescopique  
Antena telescópica

Shuttle Switch  
Molette  
Mando de lanzadera  
ENT/BAND

VOL

RADIO ON/SLEEP

OFF

**World/Local**

Telescopic Antenna  
Antenne télescopique  
Antena telescópica

Shuttle Switch  
Molette  
Mando de lanzadera  
ENT/BAND

VOL

RADIO ON/SLEEP

OFF

**World/Local**

Telescopic Antenna  
Antenne télescopique  
Antena telescópica

Shuttle Switch  
Molette  
Mando de lanzadera  
ENT/BAND

VOL

RADIO ON/SLEEP

OFF

**World/Local**

Telescopic Antenna  
Antenne télescopique  
Antena telescópica

Shuttle Switch  
Molette  
Mando de lanzadera  
ENT/BAND

VOL

RADIO ON/SLEEP

OFF

**World/Local**

Telescopic Antenna  
Antenne télescopique  
Antena telescópica

Shuttle Switch  
Molette  
Mando de lanzadera  
ENT/BAND

VOL

RADIO ON/SLEEP

OFF

**World/Local**

Telescopic Antenna  
Antenne télescopique  
Antena telescópica

Shuttle Switch  
Molette  
Mando de lanzadera  
ENT/BAND

VOL

RADIO ON/SLEEP

OFF

**World/Local**

Telescopic Antenna  
Antenne télescopique  
Antena telescópica

Shuttle Switch  
Molette  
Mando de lanzadera  
ENT/BAND

VOL

RADIO ON/SLEEP

OFF

**World/Local**

Telescopic Antenna  
Antenne télescopique  
Antena telescópica

Shuttle Switch  
Molette  
Mando de lanzadera  
ENT/BAND

VOL

RADIO ON/SLEEP

OFF

**World/Local**

Telescopic Antenna  
Antenne télescopique  
Antena telescópica

Shuttle Switch  
Molette  
Mando de lanzadera  
ENT/BAND

VOL

RADIO ON/SLEEP

OFF

**World/Local**

Telescopic Antenna  
Antenne télescopique  
Antena telescópica

Shuttle Switch  
Molette  
Mando de lanzadera  
ENT/BAND

VOL

RADIO ON/SLEEP

OFF

